



SPRAY BETTER. SPRAY:
SMARTER, FASTER, SAFER

[Pentair.com/Hypro](https://www.pentair.com/hypro)





SMARTER

FASTER

SAFER



 **PENTAIR**
HYPRO

HYPRO PROSTOP-E NOZZLE BODY
HYPRO FORCEFIELD
HYPRO SPRAY NOZZLES

SMARTER

PENTAIR HYPRO® FORCEFIELD

Benefit from superior wet seal protection

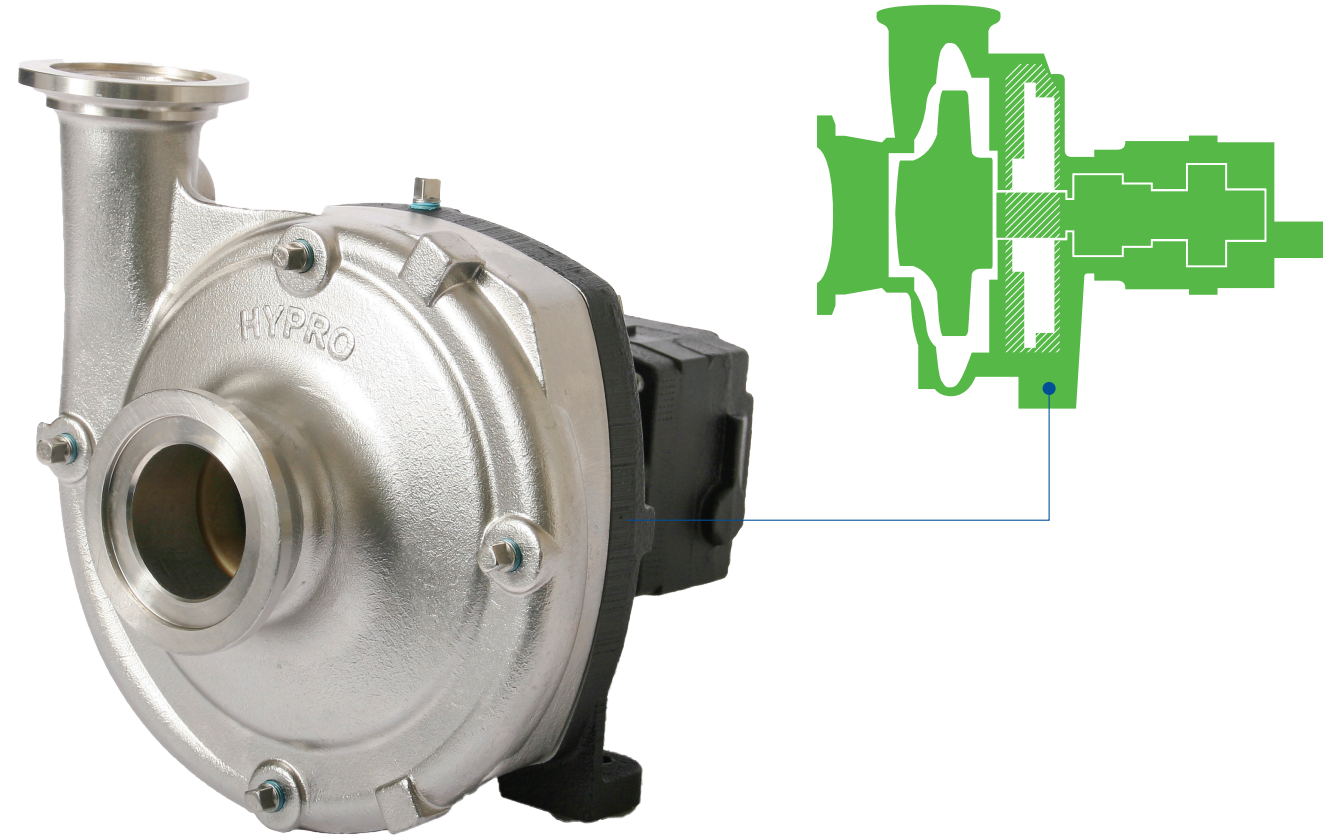

HELP AVOID \$3K-\$10K IN DOWNTIME COSTS*

ADVANTAGES

- ◆ Help minimize common failures with Pentair Hypro® ForceField wet seal chamber, which protects the mechanical seal
- ◆ Improve performance and efficiency with the self-regulating wet seal chamber

BENEFITS



WORRY-FREE OPERATION



DECREASED DOWNTIME



LONGER LIFE

*Based on costs associated with an in-season seal failure.

PENTAIR HYPRO® PROSTOP-E SINGLE NOZZLE BODY

Take advantage of individual nozzle control

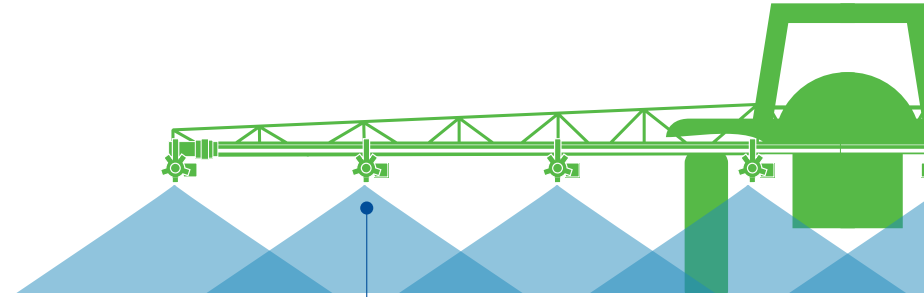

HELP REDUCE OVERSPRAYING AND SAVE ON CHEMISTRY INPUT*

ADVANTAGES

- ◆ Capitalize on individual on/off nozzle control to save on resources
- ◆ Minimize plant care product misapplication and waste
- ◆ Reduce the need for centralized valve banks

BENEFITS



LESSEN CHEMICAL COSTS



HELP INCREASE YIELD



LEVERAGE PRECISION AG NOZZLE CONTROL

*Based on testimonials from customers using Hypro ProStop-E Nozzle Bodies.

PENTAIR HYPRO® SPRAY NOZZLES

Maximize efficiency with application specific nozzles



CONTROL SPRAY DRIFT AND THE AMOUNT OF COVERAGE FOR YOUR APPLICATION

ADVANTAGES

- ◆ Select highly engineered spray nozzles for your specific application type
- ◆ Help increase the efficacy of your spraying through proper nozzle selection

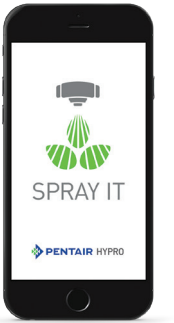

Find the right spray nozzle for your application with Hypro Spray It App. See inside back cover for details.

ESI-Six Stream

Liquid Fertilizers
Cereals



Hi-Flow

Pre-Plant Fertilizer
Burn-Down



Ultra Lo-Drift

Systemic Herbicides
Pre and Post-emerge

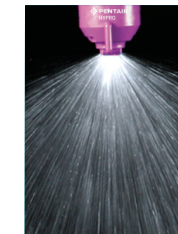

Ultra Lo-Drift Max

Dicamba and 2,4-D
Herbicides



3D Nozzle

Fungicides & Insecticides
Burn-Down

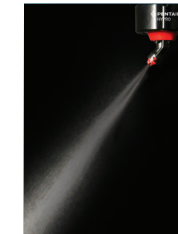

GuardianAIR Twin

Contact Herbicides
Fungicides & Insecticides
Complex Canopies





 **PENTAIR**
HYPRO

HYPRO PROSTOP-E DUAL
HYPRO CLEANLOAD MAX

FASTER

PENTAIR HYPRO® PROSTOP-E DUAL

Apply individual nozzle control with A, B, A+B functionality

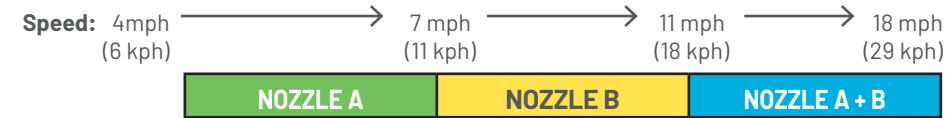

Field Examples: Turning corners or traveling up hill

Flat, open field (top speeds)



OPERATE 30% FASTER WHILE MAINTAINING SPRAY EFFICACY*

ADVANTAGES

- ◆ Switch nozzles automatically based on speed to manage droplet size
- ◆ Profit from industry leading air induction nozzles to make reliable spray application
- ◆ Rotate turrets manually. Turrets hold four nozzles operated by pairs

BENEFITS



INCREASE SPEED RANGE



CONTROL SPRAY DROPLET SIZE



LIMIT DRIFT POTENTIAL

“The virtually instantaneous shut off times of the ProStop-E is a big benefit. If you are overlapping just a little, it will shut off those outside nozzles so you are no longer overlapping.”

Mikal Sylling, Sylling Farms

*Based on product operation, nozzle sizes, speed and application rates.

PENTAIR HYPRO® CLEANLOAD MAX

Maximize your work with a large capacity education system

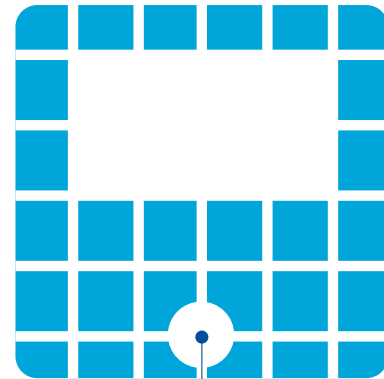

MAKE THE MOST FROM FAST EDUCATION RATES

ADVANTAGES

- ◆ Mix and load liquid and dry chemicals safely and fast
- ◆ Leverage its large 40 or 60 gallon tank for a 20:1 ratio with 800 or 1200 gallon sprayers
- ◆ Use its 2" or 3" bypass plumbing system available for direct filling

BENEFITS



FASTER FILLING



LARGE CAPACITY



FULL DRAINING WITH CONE BOTTOM TANK



INTEGRATED PROCLEAN BOTTLE RINSE



 **PENTAIR**
HYPRO

**HYPRO EXPRESS BOOM
HYPRO EXPRESS FLUSH VALVE
HYPRO CLEANLOAD**

SAFER

PENTAIR HYPRO[®] EXPRESS BOOM

Upgrade your sprayer with a high quality boom



OLD POLY BOOM



NEW EXPRESS BOOM

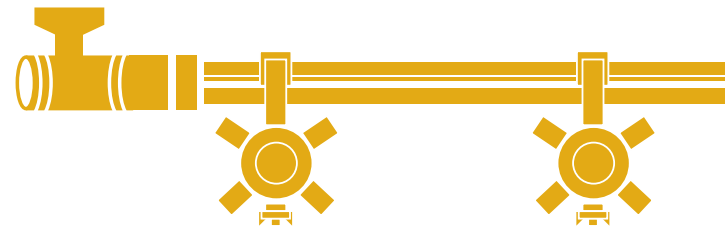

BENEFIT FROM A FAST SHUTOFF TO PROTECT SENSITIVE AREAS

ADVANTAGES

- ◆ Make use of a better spray application with upgraded technology. No more warped booms or torqued nozzle bodies
- ◆ Update old style polypropylene boom to durable stainless steel for better boom hygiene
- ◆ Help avoid crop injury caused by herbicide build-up in the boom with easy boom clean out

BENEFITS



CHANGE NOZZLE SPACING



UPGRADE TO A BUDGET FRIENDLY SYSTEM



ELIMINATE DEAD ENDS



HELP PREVENT CROSS CONTAMINATION

PENTAIR HYPRO[®] EXPRESS FLUSH VALVE

Improve boom hygiene

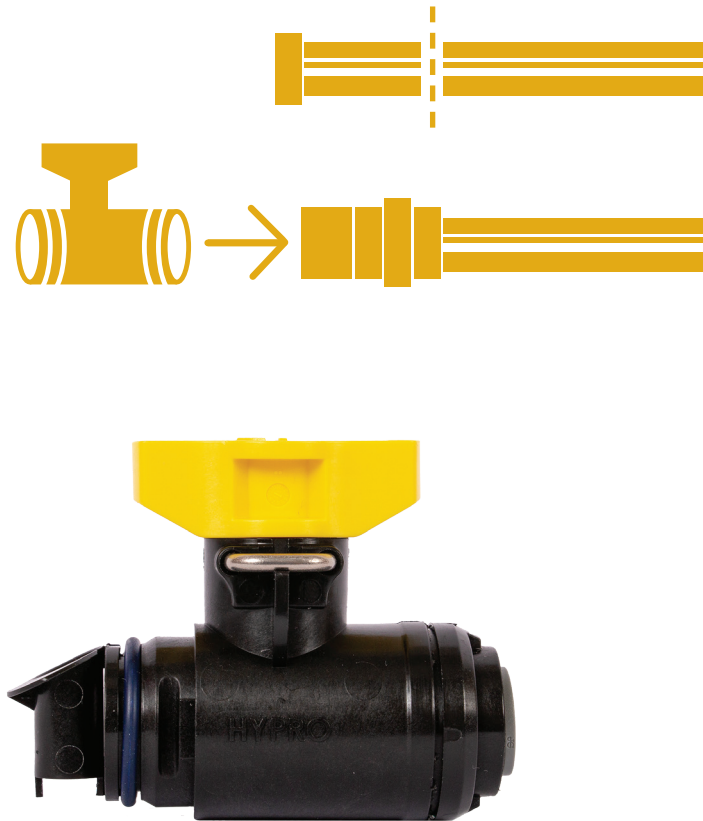

FLUSH THE ENTIRE BOOM SECTION WITH EASE BY SIMPLY TURNING THE EXPRESS FLUSH VALVE HANDLE

ADVANTAGES

- ◆ Reduce opening flush time by 55 seconds per valve compared to standard Hypro Express™ End Cap with plug
- ◆ Operate with ease as product does not require any tools to open to flushing mode
- ◆ Limit the length it extends beyond the last nozzle body to fit most boom structures with its compact design

BENEFITS



RETROFIT TO STANDARD HYPRO EXPRESS END CAP



RELIEVE TRAPPED AIR



CLEAN THE BOOM EASIER

PENTAIR HYPRO® CLEANLOAD

Load chemicals with ease



LESSEN THE POTENTIAL FOR ACCIDENTS WHILE LOADING PRODUCT IN SPRAYER

ADVANTAGES

- ◆ Load plant care product efficiently at the round level for operator safety
- ◆ Help prevent cross contamination of products with CycloRinse & ProClean bottle rinse
- ◆ Leverage triple rinse chemical containers on site for safe disposal

BENEFITS



HELP PREVENT MIXING OF PLANT CARE PRODUCT



LIMIT OPERATOR STRAIN



LOAD PRODUCT EFFICIENTLY AND FAST

SPRAY IT APP

Simplify Nozzle Selection



CHECK NOZZLE SPRAY PATTERNS

- ◆ Check individual Hypro ProStop-E spray patterns wirelessly via BlueTooth® connection

SELECT BY CHEMICAL

- ◆ Choose from 500+ chemicals

SELECT BY APPLICATION

- ◆ Simply size your nozzle based on your application

SEARCH BY PART NUMBER OR NAME

- ◆ Easily find information on a specific spray nozzle

WHERE TO BUY LISTINGS

- ◆ Quickly find a nozzle distributor near you or buy online



“Tried a lot of sprayer nozzle selection apps. My favorite these days is Hypro’s Spray It.”

Evan Sjovold, Farmer

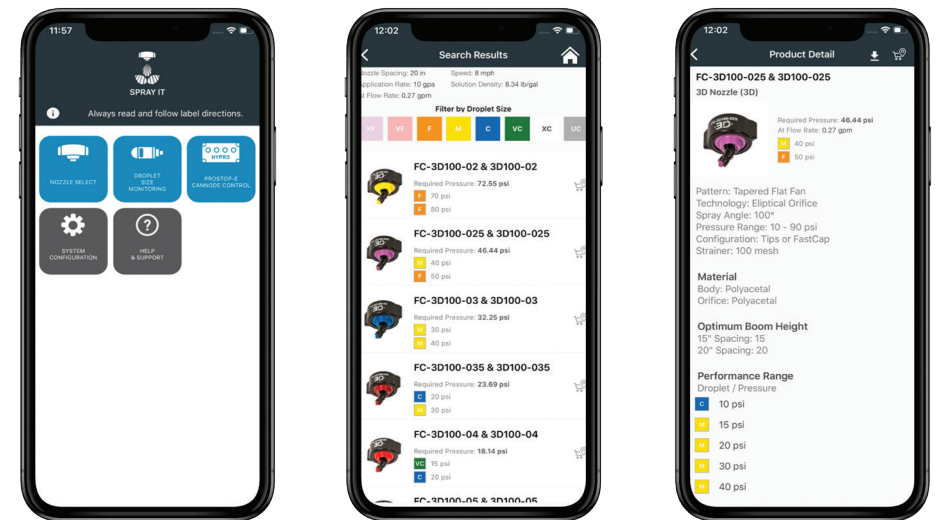

Learn how our solutions can help you spray better. Visit pentair.com/hypro



**375 Fifth Avenue NW,
New Brighton, MN
55112, USA
PH: 651-766-6300**

**Hypro EU Ltd Station Road
Longstanton, Cambridge
CB24 3DS, UK
PH: +44 1954 260245**

The Bluetooth® word mark and logos are registered trademarks owned by Bluetooth SIG, Inc.

All indicated Pentair trademarks and logos are property of Pentair. Third party registered and unregistered trademarks and logos are the property of their respective owners. Because we are continuously improving our products and services, Pentair reserves the right to change specifications without prior notice. Pentair is an equal opportunity employer.

©2021 Pentair. All Rights Reserved.

517(08-04-21)